

Urtagsmått bänkskiva - NOTERA - alla mått kontrolleras före utskärning!
Cut out worktop - NOTE - all dimensions must be checked before cutting!

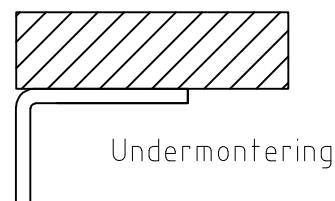
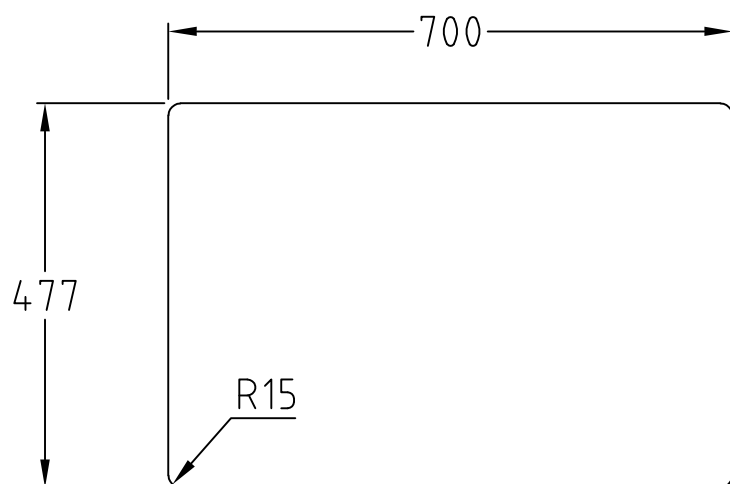
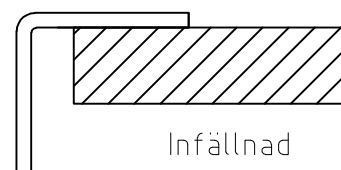
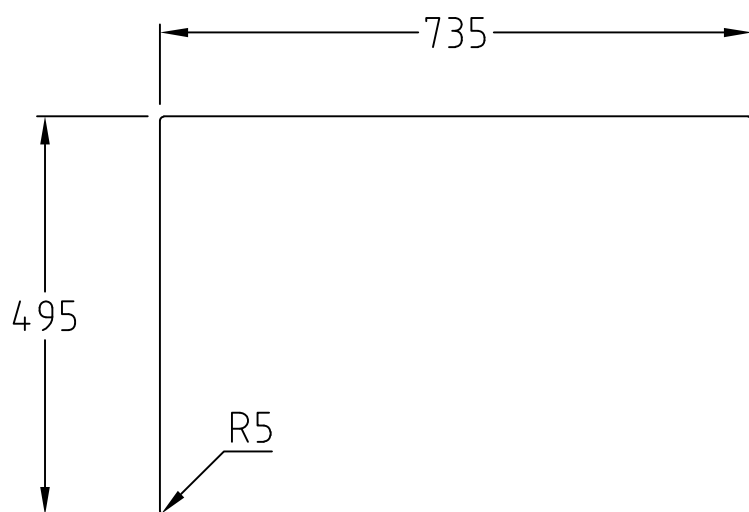
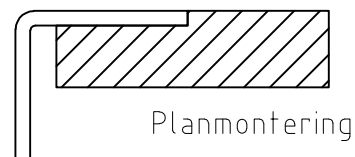
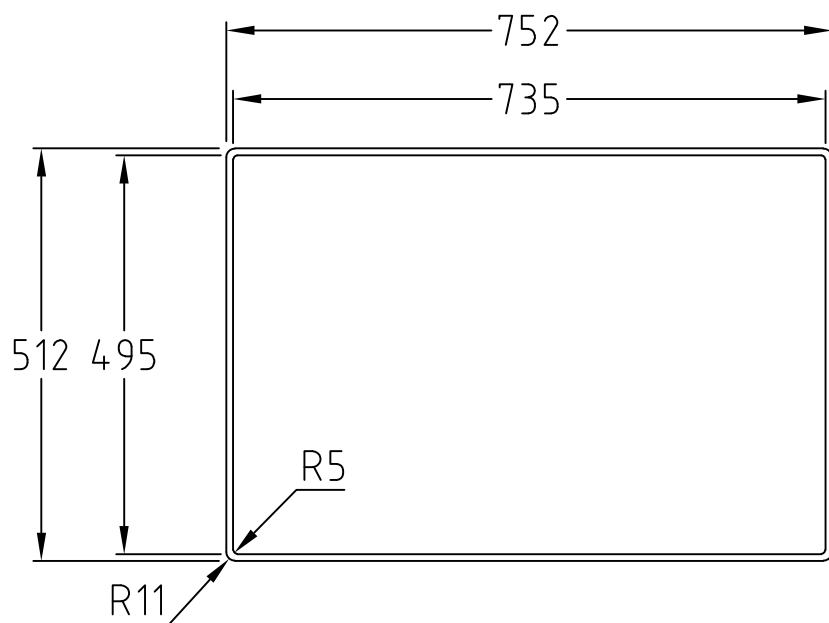

Art. number

29450

Name

XV 70 TAPWING

decosteel